

Anti-Loss Importation & Anti-Loss Duplication Rules Update

Scott M. Levine
Partner
Jones Day

Krishna Vallabhaneni
Attorney-Advisor (Tax Legislation)
U.S. Department of the Treasury
Office of Tax Policy

Eric B. Sensenbrenner
Partner
Skadden, Arps, Slate, Meagher & Flom, LLP

Chris Trump
Principal
Deloitte Tax, LLP



Washington, DC
October 1, 2013

Section 362(e) Anti-Loss Importation and Anti-Loss Duplication Provisions

- In general, sections 362(a) and (b) provide that if property was acquired by a corporation (“Acquiring”)
 - in connection with a transaction that qualifies as a section 351 exchange;
 - as paid-in surplus or a contribution to capital; or
 - in connection with a reorganization,

then Acquiring’s basis in the transferred property is the same as the basis of such property in the hands of the transferor of such property, increased by the amount of gain recognized by the transferor on the transfer.

- Section 362(e) was enacted in 2004 as part of the American Jobs Creation Act to prevent built-in losses from being imported or duplicated in certain transferred basis transactions.
- If applicable, sections 362(e)(1) and (2) may require Acquiring to adjust its basis in certain property received in transactions described in sections 362(a) and (b).

Section 362(e)(1)

The Anti-Loss Importation Rule

Anti-Loss Importation Rule

Section 362(e)(1)

- Section 362(e)(1) prevents the importation of built-in losses and applies if a transaction:
 1. is a contribution to capital or qualifies as a section 351 exchange, a section 361 exchange, or a section 368 stock-for-stock exchange (i.e., the transaction is described in sections 362(a) or (b)) (each a “Section 362 Transaction”);*
 2. involves the transfer of Importation Property (defined later); and
 3. involves the importation of a net built-in loss.
- If section 362(e)(1) applies to a Section 362 Transaction, the basis of each item of Importation Property in the hands of the Acquiring corporation, regardless of whether it is a built-in loss item or a built-in gain item, is equal to such property’s FMV immediately after the transaction (i.e., each Importation Property must be marked-to-market).
- Rules similar to section 362(e)(1) apply under section 334(b)(2).

*See Prop. Treas. Reg. section 1.362-3(c)(1).

Section 362(e)(1) Example

**Prior to Transaction
(in hands of F)**

Asset 1	
A/B	\$100
FMV	\$60
BIL	\$(40)

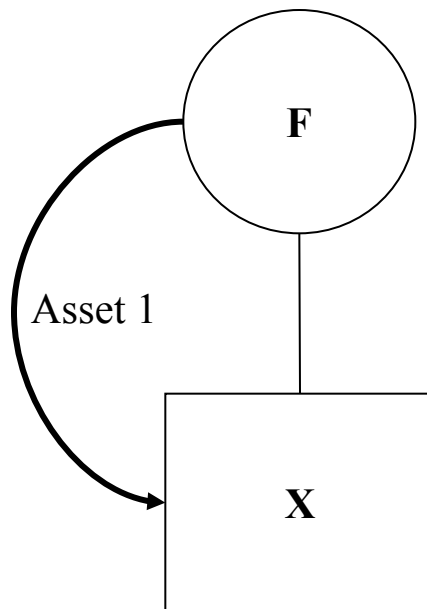

**After Transaction
(in hands of X)**

Asset 1	
A/B	\$60
FMV	\$60
BIL	\$0

Importation of a Net Built-In Loss

Section 362(e)(1)(C)

- A transaction results in an “importation of a net built-in loss” if Acquiring’s aggregate adjusted basis in the Importation Property would (but for section 362(e)(1)) exceed the aggregate FMV of such property immediately after the transaction.
- The statute is arguably unclear as to whether an importation of net built-in loss is determined by:
 - aggregating the Importation Property transferred by all transferors in a single transaction, or
 - looking at Importation Property on a transferor-by-transferor basis.

Prop. Treas. Reg. Section 1.362-3

- On September 6, 2013, REG-161948-05, 78 F.R. 54971, was released containing proposed regulations under sections 334(b)(1)(B) and 362(e)(1) (the “Proposed Regulations”).
- The Proposed Regulations provide that Acquiring’s basis in Importation Property acquired in a Loss Importation Transaction is equal to the value of the property immediately after the transaction.
- The determination as to whether property is Importation Property is based upon a “hypothetical sale” construct. Prop. Treas. Reg. section 1.362-3(c)(2).
- A “Loss Importation Transaction” generally is any Section 362 Transaction in which Acquiring’s aggregate basis in *all* Importation Property received from *all* transferors in the transaction would exceed the aggregate value of such property immediately after the transaction. Prop. Treas. Reg. section 1.362-3(c)(3).
- The Proposed Regulations do not address how a foreign transferor with a functional currency that is not the U.S. dollar should calculate basis in property potentially subject to section 362(e)(1).

Prop. Treas. Reg. Section 1.362-3(f)

Example 1, Scenario (i) (Section 351 Transaction)

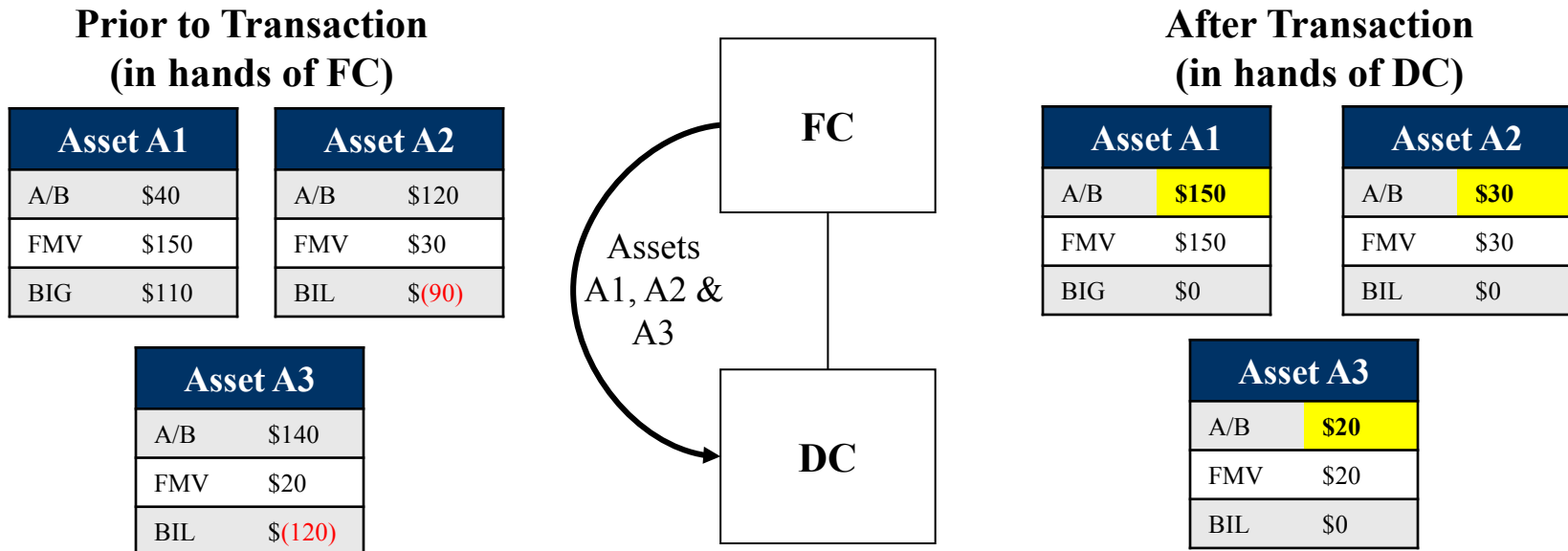

- A1, A2, and A3 are Importation Properties.
- The transfer is a Section 362 Transaction.

Prop. Treas. Reg. Section 1.362-3(f) Reorganization Example

Prior to Transaction (in hands of FC)

Asset A1	
A/B	\$40
FMV	\$150
BIG	\$110

Asset A2	
A/B	\$120
FMV	\$30
BIL	\$(90)

Asset A3	
A/B	\$140
FMV	\$20
BIL	\$(120)

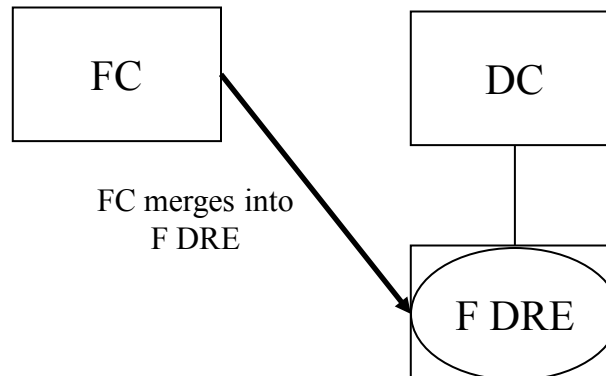

After Transaction (in hands of DC)

Asset A1	
A/B	\$150
FMV	\$150
BIG	\$0

Asset A2	
A/B	\$30
FMV	\$30
BIL	\$0

Asset A3	
A/B	\$20
FMV	\$20
BIL	\$0

- Assume all facts are the same as in Example 1, Scenario (i), except that FC merges into a disregarded entity wholly owned by DC in a reorganization described in section 368(a)(1)(A).
- The results and analysis are the same as in Example 1, Scenario (i) on the previous slide.

Prop. Treas. Reg. Section 1.362-3(f)

Example 2: Aggregate Approach

Prior to Transaction

Asset A1	
A/B	\$40
FMV	\$150
BIG	\$110

Asset A2	
A/B	\$120
FMV	\$30
BIL	\$(90)

Asset A3	
A/B	\$140
FMV	\$20
BIL	\$(120)

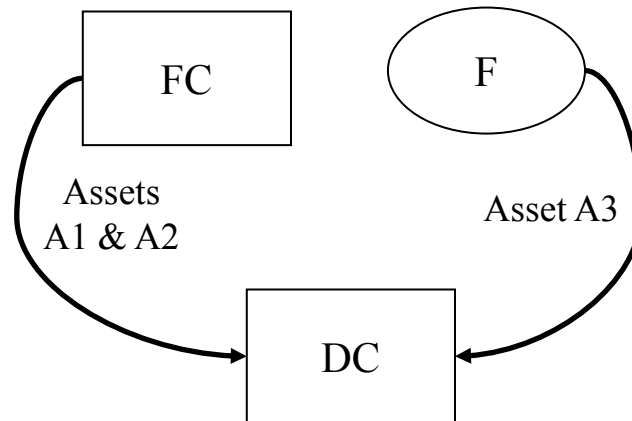

After Transaction (in hands of DC)

Asset A1	
A/B	\$150
FMV	\$150
BIG	\$0

Asset A2	
A/B	\$30
FMV	\$30
BIL	\$0

Asset A3	
A/B	\$20
FMV	\$20
BIL	\$0

- A1, A2, and A3 are Importation Property.
- The results are the same as in Example 1, Scenario (i).
- Even though FC is not transferring property with a net built-in loss, Prop. Treas. Reg. section 1.362-3(c)(3) states that the *aggregate approach* applies so both transfers in the aggregate constitute a Loss Importation Transaction.

Definition of Importation Property

Section 362(e)(1)(B)

- Importation Property is any property if:
 - (i) “gain or loss with respect to such property is not subject to [U.S. federal income tax] *in the hands of the transferor* immediately before the transfer,” and
 - (ii) “gain or loss with respect to such property is subject to such tax *in the hands of [Acquiring]* immediately after such transfer.”
- The statute is not clear about whether Importation Property includes property held by a:
 - CFC;
 - Foreign person engaged in a U.S. trade or business; or
 - RIC, REIT, cooperative, estate, or trust.

“Importation Property” Definition Clarified

Prop. Treas. Reg. Section 1.362-3(d) and (e)

- The Importation Property determination depends on a hypothetical sale of the property by the transferor before the transaction and Acquiring after the transaction.
 - This construct could lead to different results when compared to a rule that examines whether the seller would actually have any U.S. federal income tax liability in the taxable year of the transaction.
 - This construct is generally consistent with the statute’s focus on whether gain or loss on the property is subject to U.S. income tax *in the hands of* the transferor or Acquiring, as the case may be. Section 362(e)(1)(B).
- If the hypothetical seller is a partnership, S corporation, or grantor trust, the determination is made based on the tax treatment of the seller’s partners, shareholders, or owners as if they held the property directly. Prop. Treas. Reg. section 1.362-3(d)(2).
 - An organizing instrument containing a special allocation of gain or loss governs each owner’s hypothetical gain or loss. Prop. Treas. Reg. section 1.362-3(e)(1).
 - There are special rules for CFCs, RICS, REITs, cooperatives, non-grantor trusts, and estates.

Application to CFCs and PFICs

Prop. Treas. Reg. Section 1.362-3(d)(3)

- In general, property held by a CFC or a PFIC is not treated as being subject to U.S. federal income tax.
 - Prop. Treas. Reg. section 1.362-3(d)(3) states that “gain or loss that would be recognized by a CFC . . . or a PFIC . . . is not deemed taken into account in determining a Federal income tax liability solely because it could affect an inclusion under section 951(a) or section 1293(a).”
- However, property held by a foreign person (including a CFC or PFIC) that is effectively connected with the conduct of a U.S. trade or business or deemed effectively connected under section 897 is treated as being subject to U.S. federal income tax. 78 F.R. 54973; Prop. Treas. Reg. section 1.362-3(f), Ex. 7.
- Contrast with section 163(j) and Prop. Treas. Reg. section 1.163(j)-4(d)(1)(i), which treat interest paid to a CFC as subject to U.S. federal income tax if included in the income of a U.S. shareholder under section 951(a).

Income Tax Treaties

- The preamble to the Proposed Regulations states that “in the case of an applicable income tax treaty, the determination of whether property is [I]mportation [P]roperty would take into account whether the transferor would be taxable under the business profits article or gains article of the income tax treaty.”
 - Under most U.S. income tax treaties, the business profits of an enterprise of a contracting state are taxable only in that state unless those business profits are attributable to a permanent establishment of the enterprise in the other contracting state. U.S. Model Treaty Art. 5, 7.
 - Gains from the alienation of property may be taxed in the state of residence of the alienator and/or the state where the property is located, depending on the applicable sub-rule. U.S. Model Treaty Art. 13.

Prop. Treas. Reg. Section 1.362-3(f)

Example 7, Scenario (i): General CFC Example

**Prior to Transaction
(in the hands of FC)**

Asset A1	
A/B	\$70
FMV	\$100
BIG	\$30

Asset A2	
A/B	\$100
FMV	\$75
BIL	\$(25)

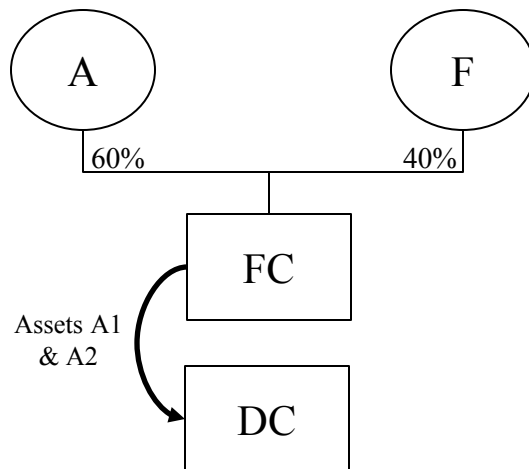

**After Transaction
(in the hands of DC)**

Asset A1	
A/B	\$70
FMV	\$100
BIG	\$30

Asset A2	
A/B	\$75
FMV	\$75
BIL	\$0

- FC is a CFC of which A is a U.S. shareholder.
- Assume that A1 is used in a U.S. trade or business, but A2 is not.
- A2 is Importation Property, but A1 is not.
- Because A1 is not Importation Property, it is not relevant in determining whether the transfer is a Loss Importation Transaction.

CFC-to-CFC Transfer Example

**Prior to Transaction
(in hands of CFC1)**

Asset A1	
A/B	\$100
FMV	\$70
BIL	\$(30)

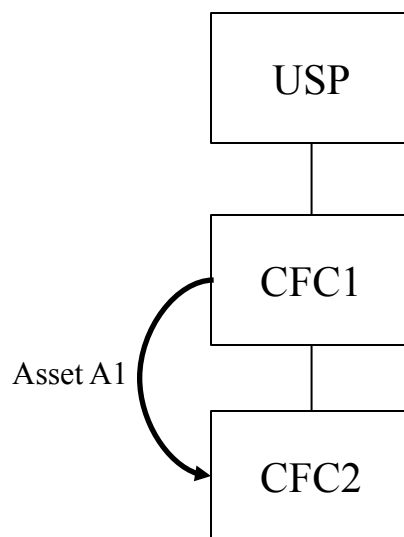

**After Transaction
(in hands of CFC2)**

Asset A1	
A/B	\$100
FMV	\$70
BIL	\$(30)

- Assume neither CFC1 nor CFC2 is engaged in a U.S. trade or business.
- Asset A1 is not Importation Property.

Prop. Treas. Reg. Section 1.362-3(f)

Example 7, Scenario (ii): Transfer of CFC stock

Prior to Transaction

A's FC Stock	
A/B	\$80
FMV	\$105
BIG	\$25

F's FC Stock	
A/B	\$100
FMV	\$70
BIL	\$(30)

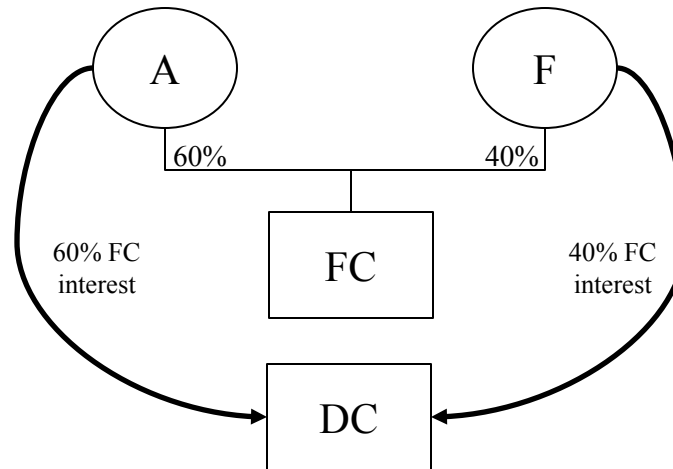

After Transaction (in hands of DC)

A's FC Stock	
A/B	\$80
FMV	\$105
BIG	\$25

F's FC Stock	
A/B	\$70
FMV	\$70
BIL	\$0

- F's FC stock is Importation Property; A's FC stock is not.
- F's transfer of FC stock is a Loss Importation Transaction.

Importation Property Partnership-Related Issues

- When a partnership transfers property in a Section 362 Transaction, each partner is treated as holding its proportionate share of the property of such partnership. Section 362(e)(1)(B).
- Neither the statute nor the legislative history provides guidance on whether the proportionate share is based on a capital or a profits interest in the partnership.
 - A partnership's organizing document may not provide sufficient information to determine how gain or loss from a hypothetical sale would be allocated among the partners.
- The statute does not provide that the FMV of a partnership interest includes a partner's share of partnership liabilities that would be discharged in a sale of such interest.*
- Similar issues arise regarding the classification of property owned by other pass-through entities such as S corporations and grantor trusts.

* See discussion of the same issue under section 362(e)(2) on Slides 51-56.

“Tentatively Divided” Property

Prop. Treas. Reg. Section 1.362-3(e)

- Gain or loss includible in the income of more than one person is “tentatively divided” into portions proportionate to each person’s allocable share of the gain or loss. Each portion can separately qualify as Importation Property. Prop. Treas. Reg. section 1.362-3(e)(2).
- Immediately after applying section 362(e)(1) and before the application of section 362(e)(2), any tentatively divided property is re-constituted into a single property. Prop. Treas. Reg. section 1.362-3(e)(3). Acquiring takes basis in the re-constituted property equal to the sum of:
 - The FMV of each tentatively divided portion that was Importation Property, provided the transaction was a Loss Importation Transaction, plus
 - Acquiring’s basis in each tentatively divided portion that was not Importation Property received in a Loss Importation Transaction, determined under sections 362(a) and (b).
- Acquiring would hold the tentatively divided property with a single undivided basis. *Cf.* Treas. Reg. section 1.358-2(a)(2)(vi).

Prop. Treas. Reg. Section 1.362-3(f)

Example 5, Scenario (i): “Tentatively Divided” Property

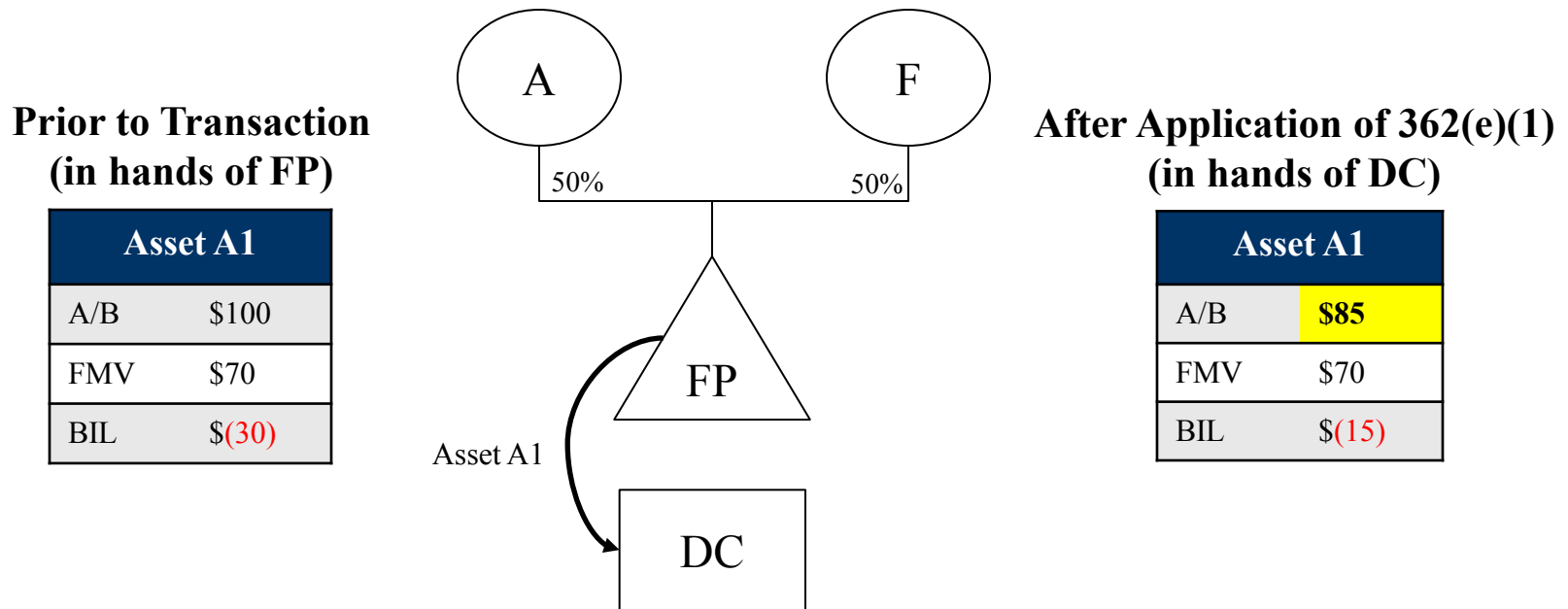

- A1 is tentatively divided into two equal portions owned by A and F, each portion having a \$50 basis and a \$35 FMV.
- F’s portion of A1 is Importation Property; A’s portion is not.
- Making FP a domestic partnership does not change this result because whether a partnership’s property is Importation Property is determined by reference to the persons that would be required to include the partnership’s gain or loss in their taxable income. Prop. Treas. Reg. section 1.362-3(d)(2).

Application to Other Pass-Through Entities

Prop. Treas. Reg. Section 1.362-3(d)(4)

- The preamble to the Proposed Regulations states that the following domestic “OPT Entities” are generally treated as being subject to U.S. federal income tax for purposes of the Importation Property rules:
 - RICS
 - REITs
 - Cooperatives
 - Non-Grantor Trusts
 - Estates
- Is a publicly-traded partnership (as defined under section 7704) treated as being subject to U.S. federal income tax for purposes of the Importation Property rules? Should it be?

Pass-Through Anti-Avoidance Rule

Prop. Treas. Reg. Section 1.362-3(d)(4)

- An anti-avoidance rule applies if an OPT Entity “transfers, directly or indirectly, property that was transferred to or acquired by it as part of a plan (whether of transferor, Acquiring, or any other person) to avoid the application of section 362(e)(1) to a [Section 362 Transaction].”
- If the anti-avoidance rule applies, Prop. Treas. Reg. section 1.362-3(d)(4)(ii) states that:
 - A. “The [OPT Entity] is treated as though it distributes the proceeds of the hypothetical sale”;
 - B. “To the fullest extent possible under the [OPT Entity’s] organizing instrument . . . the deemed distribution is treated as made to a distributee or distributees that would not take distributions from the [OPT Entity] into account in determining a Federal income tax liability”; and
 - C. “The determination of whether the gain or loss on the hypothetical sale is treated as subject to Federal income tax is made by reference to the deemed distributee or distributees.”

Pass-Through Anti-Avoidance Rule

Open Issues

- What is the purpose for the deemed distribution of hypothetical sale proceeds? Why didn't the anti-avoidance rule instead use the partnership look-through rule under Prop. Treas. Reg. section 1.362-3(d)(2)?
- Under the anti-avoidance rule as currently drafted, what is the OPT Entity's basis in Acquiring?

Pass-Through Anti-Avoidance Rule Domestic Trust Example

Prior to Transaction (in hands of F)

Asset 1	
A/B	\$100
FMV	\$40
BIL	\$(60)

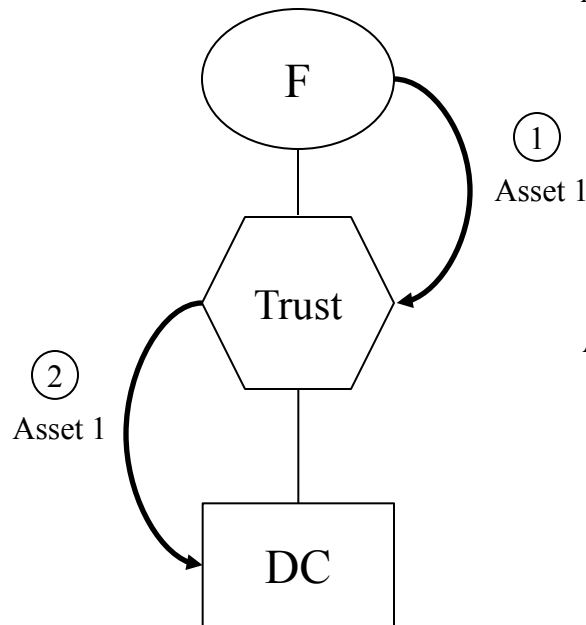

After Transaction and Before Application of Anti-Avoidance Rule (in hands of DC)

Asset 1	
A/B	\$100
FMV	\$40
BIL	\$(60)

After Transaction and After Application of Anti-Avoidance Rule (in hands of DC)

Asset 1	
A/B	\$40
FMV	\$40
BIL	\$0

- Section 362(e)(1) does not apply to Step 1 because Acquiring (i.e., Trust) is not a corporation (and therefore the transfer is not a Section 362 Transaction).
- F transfers Asset 1 to Trust as part of a plan to have Trust transfer Asset 1 to DC to avoid the application of section 362(e)(1).
- Trust and DC make a section 362(e)(2)(C) election with respect to Step 2. The election would be available absent the application of the anti-abuse rule provided that the trustee of Trust is a U.S. person.

Pass-Through Anti-Avoidance Rule REIT Example

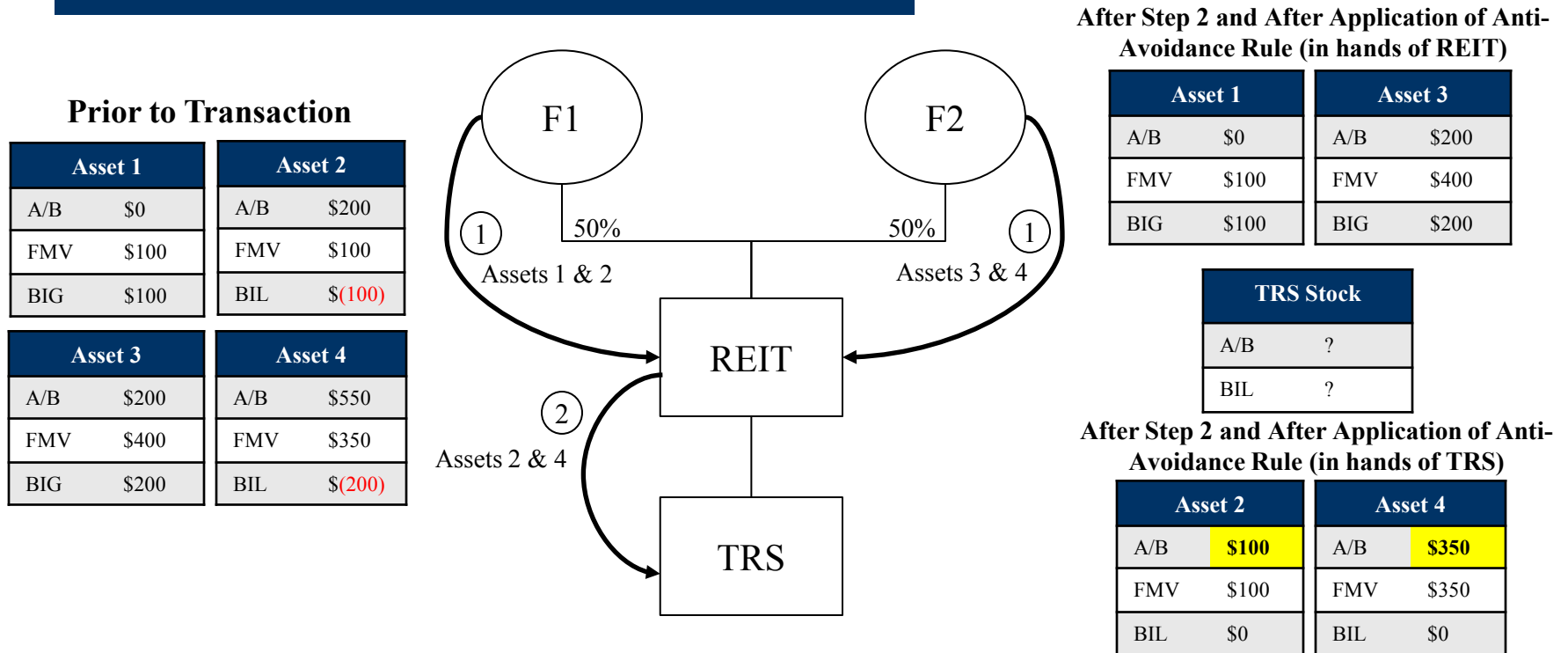

- Sections 362(e)(1) and (2) do not apply to Step 1 (Step 1 is neither a Loss Importation Transaction nor a Loss Duplication Transaction).
- F1 transfers Asset 1 and Asset 2 to REIT as part of a plan to have REIT transfer Asset 2 to TRS to avoid the application of section 362(e)(1).
- REIT and TRS make a section 362(e)(2)(C) election with respect to Step 2. The election would be available absent the application of the anti-avoidance rule.

Triangular Reorganizations

Prop. Treas. Reg. Section 1.358-6

- For purposes of determining P's stock basis in S, Treas. Reg. section 1.358-6(c) generally provides that in a forward triangular reorganization involving a corporation (T) that merges into another corporation (S) that is wholly-owned by a third corporation (P), the following is deemed to occur:
 1. P acquires the T assets in a transaction to which section 362(b) applies; and
 2. P then transfers the T assets to S in a transaction in which P's basis in its S stock is determined pursuant to section 358.

Section 362(b), not Treas. Reg. section 1.358-6(c), addresses S's basis in assets actually acquired from T.

- Prop. Treas. Reg. section 1.358-6(c)(1)(i)(A) states that in a triangular merger, section 362(e)(1) applies to the deemed transfer of T assets to P.
- Prop. Treas. Reg. sections 1.358-6(c)(2)(ii)(B) and 1.358-6(c)(3) provide *similar* rules for the application of section 362(e)(1) to reorganizations under section 368(a)(2)(E) and triangular B reorganizations.
- Prop. Treas. Reg. section 1.362-3(f), Ex. 9 provides that section 362(e)(1) still applies to any T assets actually acquired by S in a triangular merger. *Cf.* Treas. Reg. section 1.362-4(h), Ex. 10 (section 362(e)(1) not applicable to T assets acquired by S in a triangular merger).

Prop. Treas. Reg. Section 1.362-3(f)

Example 9, Scenario (i)

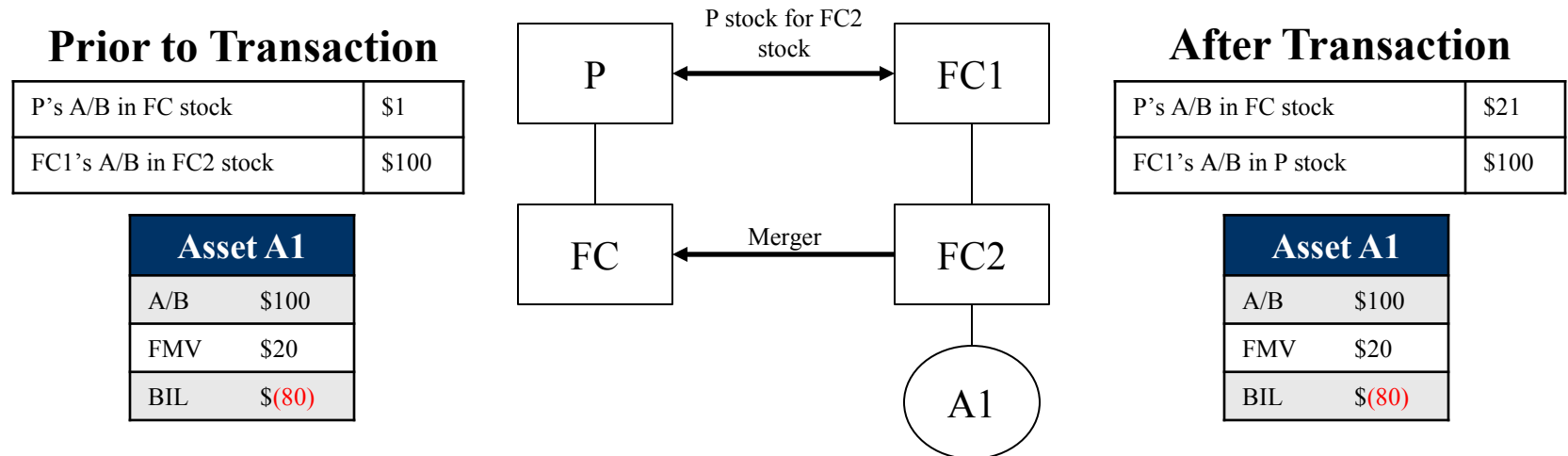

- To determine P's basis in its FC stock, FC2 is deemed to transfer A1 to P. Section 362(e)(1) applies because A1 is Importation Property transferred in a Loss Importation Transaction.
- P's deemed basis in A1 is reduced to \$20, and upon the deemed transfer of A1 to FC, P's aggregate basis in its FC stock increases to \$21 under the principles of Treas. Reg. section 1.367(b)-13.
- The deemed transfer of A1 from FC2 to P and P to FC does not apply to determine the basis of A1 in FC's hands.
- If FC were a domestic corporation, section 362(e)(1) would apply to FC2's transfer of A1 to FC.

Prop. Treas. Reg. Section 1.358-6(c)(1)(i): Does Section 362(e)(2) Apply to the Deemed Drop Down?

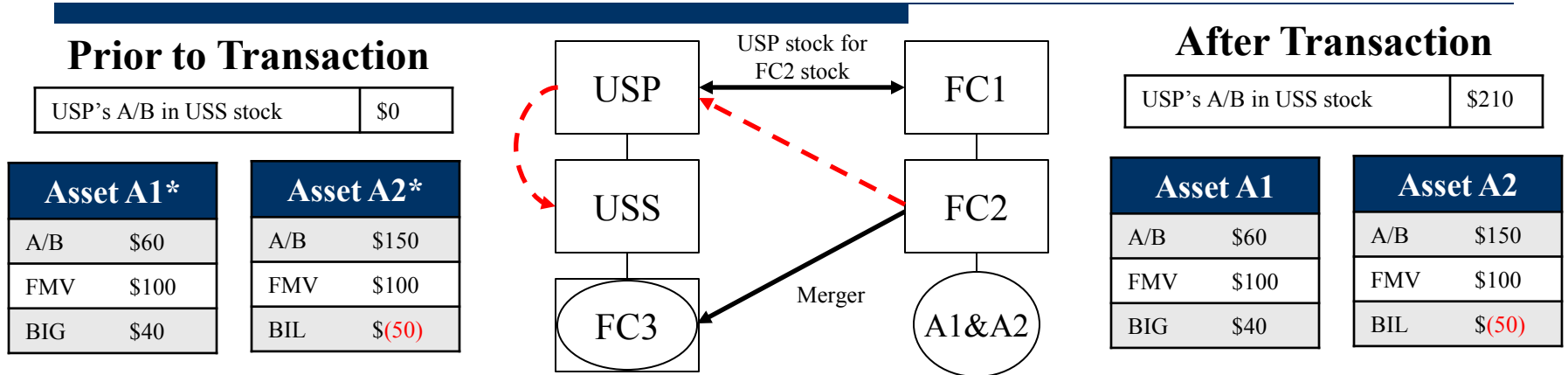

- Prop. Treas. Reg. section 1.358-6(c)(1)(i)(A) provides that USP's basis in the assets deemed received from FC2 is determined under section 362(b) "taking into account the provisions of section 362(e)(1)."
- Thus, USP's basis in A1 and A2 would be \$60 and \$150, respectively because A1 is the only Importation Property transferred in the deemed section 361 exchange and, as a result, section 362(e)(1) does not apply to the exchange. Further, section 362(e)(2) does not apply because the exchange was not described in section 362(a).
- The Proposed Regulations do not amend Treas. Reg. section 1.358-6(c)(1)(i)(B) which provides that USP would be treated as transferring A1 and A2 to USS "in a transaction in which [USP]'s basis in [USS] stock was determined under section 358." Cf. Prop. Treas. Reg. section 1.358-6(c)(3)(ii) (with respect to P's deemed transfer of T stock to S, P is treated as if "P transferred the T stock to S in a transaction in which P's basis in its S stock was determined under section 358 (*taking into account the provisions of section 362(e)(2) to the extent the transfer is a transaction described in section 362(a).*")."
- As an express provision was not added to provide for the application of section 362(e)(2) to USP's deemed transfer of A1 and A2 to USS, USP would appear to take a \$210 basis (and a \$10 built-in loss) in its USS stock.

*A1 is *not* subject to U.S. tax in FC2's hands. A2 is subject to U.S. tax in FC2's hands.

Prop. Treas. Reg. Section 1.358-6(c)(1)(i) vs. Prop. Treas. Reg. Section 1.358-6(c)(3)

- Query why Treasury and the IRS would mandate the application of section 362(e)(2) in a triangular B reorganization but not in a forward triangular merger?
- In a forward triangular merger, the actual asset transfer is an exchange described in section 362(b) and not section 362(a). *See* Rev. Rul. 84-44, 1984-1 C.B. 105. Likewise, in a triangular B reorganization, the actual target stock transfer is an exchange described in section 362(b) and not section 362(a) (i.e., the T shareholders actually received T stock as opposed to S stock).
- We understand that the IRS and Treasury concluded that it was inappropriate to “deem” a section 351 exchange to the extent there was not an actual (or deemed) section 351 exchange *without regard to the triangular basis regulations*.
- In a triangular B reorganization where the target shareholders control the issuing corporation immediately after the exchange, Treas. Reg. section 1.358-6(c)(3)(i) deems that P acquired the T stock actually acquired by S directly from the T shareholders “in a transaction in which P’s basis in the T stock was determined *under section 362(b)*” notwithstanding that such a deemed exchange would qualify as both a section 361 exchange and a section 351 exchange. (Emphasis added).
- Further, Prop. Treas. Reg. section 1.358-6(c)(3)(ii) provides that P’s basis in its S stock with respect to P’s “deemed” transfer of the T stock to S is determined under section 358 “taking into account the provisions of section 362(e)(2) *to the extent* the transfer is a transaction described in section 362(a).” (Emphasis added).
 - If the IRS and Treasury are not “deeming” section 351 exchanges for purposes of the triangular basis regulations, why would section 362(e)(2) apply to P’s deemed transfer of the T stock to S?
 - If the IRS and Treasury believe that section 362(e)(2) is turned off only on P’s deemed second step transfer of T assets or stock (as the case may be) to S, why is the reference to section 362(e)(2) placed in Prop. Treas. Reg. section 1.358-6(c)(3)(ii) as opposed to Prop. Treas. Reg. section 1.358-6(c)(3)(i)?

Prop. Treas. Reg. Section 1.362-3(f)

Example 8, Scenario 1: Withholding Tax

Prior to Transaction (in hands of FC)

FC's DC1 Stock	
A/B	\$100
FMV	\$70
BIL	\$(30)

1 share of
DC1 stock

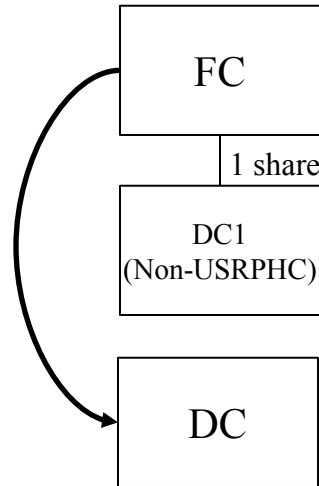

After Transaction (in hands of DC)

FC's DC1 Stock	
A/B	\$70
FMV	\$70
BIL	\$0

- FC holds its DC1 stock as an investment. Dividends on the DC1 stock are subject to FDAP and 30% U.S. federal withholding. Sections 881(a), 1442(a).
- Even though dividends paid to FC on its DC1 stock are subject to U.S. withholding, no gain or loss on FC's sale of DC1 stock would be subject to U.S. federal income tax. Therefore, consistent with the hypothetical sale approach in Prop. Treas. Reg. section 1.362-3(c)(2), and although not explicitly otherwise provided in the preamble or text of the Proposed Regulations, FC's stock in DC1 is Importation Property.

Treatment of OID Instrument Example

Prior to Transaction (in hands of FC)

U.S. OID Instrument	
A/B	\$100
Issue Price	\$100
Redemption Price	\$140
Accrued OID	\$10
FMV	\$60
BIL	\$(40)

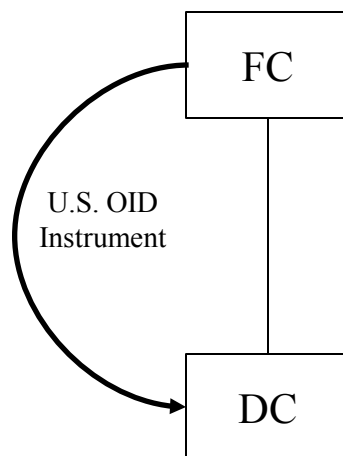

After Transaction (in hands of DC)

U.S. OID Instrument	
A/B	?
FMV	\$60
BIL	?

- Because the redemption price exceeds the issue price, the instrument is an OID instrument in FC's hands. Section 1273(a).
- On a hypothetical sale of the OID Instrument, FC would be subject to U.S. gross basis taxation on the amount of OID accrued but not paid of \$10. Section 881(a)(3)(A). Consider withholding implications.
- Does the gross tax imposed on FC under section 881(a)(3)(A) on a hypothetical sale cause the OID Instrument to not be Importation Property?

Reporting Requirements

Prop. Treas. Reg. Sections 1.332-6, 1.351-3, 1.368-3

- Prop. Treas. Reg. sections 1.351-3(a)(3) and (b)(3) require certain section 351 transferors and transferees to include a statement with their tax returns in the year of the section 351 transaction.
 - The statement must provide the FMV and basis of the property transferred in the exchange immediately before such exchange, separately divided into four categories:
 1. The aggregate of all Importation Property transferred in a Loss Importation Transaction;
 2. The aggregate of all Loss Duplication Property under section 362(e)(2) as defined in Treas. Reg. section 1.362-4(c)(1);
 3. The aggregate of all property with respect to which any gain or loss was recognized on the transfer; and
 4. The aggregate of all remaining property transferred.
- Prop. Treas. Reg. sections 1.368-3(a)(3) and (b)(3) contain a mirror rule for reorganizations subject to section 362(e)(1).
- Prop. Treas. Reg. section 1.332-6 contains a similar rule for liquidations subject to section 334(b)(1)(B).

Section 362(e)(1)/334(b)(1)(B) & Section 367(b) Overlap Issues

- Issues arise when both section 367(b) and section 362(e)(1) or section 334(b)(1)(B) apply to the same transaction.
- The preamble to the Proposed Regulations provides that:

Comments are specifically requested on the appropriate treatment of transactions subject to both section 367(b) and either section 334(b)(1)(B) or 362(e)(1). Comments are also specifically requested on what effect a basis reduction required under section 334(b)(1)(B) or section 362(e)(1) may have on earnings and profits and any inclusion required under § 1.367(b)-3.

78 F.R. 54971, 54975.

Treas. Reg. Section 1.367(b)-3 Example

Prior to Transaction (in hands of CFC)

CFC's previously untaxed E&P	\$60
------------------------------	------

Asset 1	
A/B	\$100
FMV	\$40
BIL	\$(60)

CFC completely liquidates distributing Asset 1 to USP

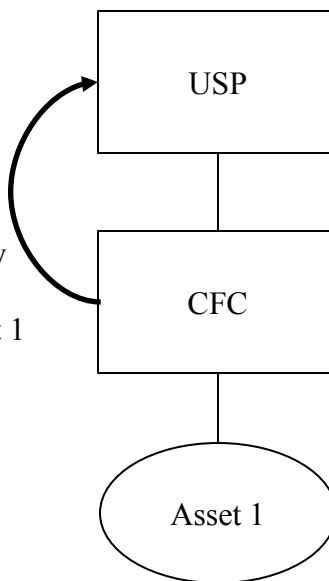

After Transaction (in hands of USP)

USP income inclusion	?
----------------------	---

Asset 1	
A/B	\$40
FMV	\$40
BIL	\$0

- Upon liquidation, Treas. Reg. section 1.367(b)-3(b)(3) generally requires USP to include in income a \$60 deemed dividend (i.e., an amount equal to CFC's all E&P amount).
- Prop. Treas. Reg. section 1.334-1(b)(3) applies to the transfer of Asset 1 to USP because Asset 1 is Importation Property being transferred in a Loss Importation Transaction, resulting in USP taking a \$40 basis in Asset 1.

Treas. Reg. Section 1.367(b)-3 Example (Cont'd)

Prior to Transaction (in hands of CFC)

CFC's previously untaxed E&P	\$60
------------------------------	------

Asset 1	
A/B	\$100
FMV	\$40
BIL	\$(60)

CFC completely liquidates distributing Asset 1 to USP

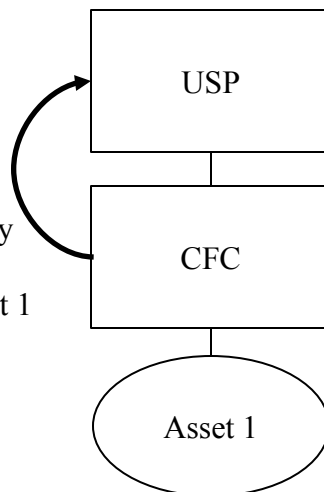

After Transaction (in hands of USP)

USP income inclusion	?
----------------------	---

Asset 1	
A/B	\$40
FMV	\$40
BIL	\$0

- When both section 362(e)(1) and Treas. Reg. section 1.367(b)-3(b) technically apply to the same transaction, may CFC reduce its E&P immediately prior to the liquidation by the amount of basis reduction mandated under section 334(b)(1)(B)? *See* Rev. Rul. 71-165, 1971-1 C.B. 111 (disallowable deductions under the Code generally still result in E&P reduction unless Code specifically provides otherwise); *cf.* Treas. Reg. section 1.267(f)-1(g) (section 267(f) deferred loss does not reduce E&P until loss taken into account suggesting that section 267(a)(1) disallowed loss should reduce corporate seller's E&P); *but see* Treas. Reg. section 1.367(b)-2(e)(3)(ii) (providing that inclusion of all E&P amount occurs prior to the exchanging shareholder's (i.e., USP) receipt of consideration (i.e., Asset 1) for its stock in the foreign corporation (i.e., CFC)).
- At least from a policy perspective, should the result depend upon whether or not the reduction in FMV of Asset 1 occurred *prior* to USP's acquisition of CFC? Does a rule permitting CFC to reduce its E&P immediately prior to the inclusion of the all E&P amount even when USP owned CFC when Asset 1 declined in value encourage the expatriation of domestic assets?

Section 362(e)(2)

The Anti-Loss Duplication Rule

Anti-Loss Duplication Rule

Section 362(e)(2)

- Section 362(e)(2) prevents the duplication of built-in losses and applies if each of the following three conditions are satisfied:
 1. The transaction is a contribution to capital or a section 351 exchange (i.e., the transaction is described in section 362(a));
 2. Section 362(e)(1) does not apply to the property transferred; and
 3. Acquiring's aggregate adjusted basis in the property transferred would (but for section 362(e)(2)) exceed the aggregate FMV of such property immediately after the transaction.
- If section 362(e)(2) applies, Acquiring's aggregated adjusted bases in the properties transferred in the section 362(a) transaction "shall not exceed the FMV of such property immediately after such transaction."
- The aggregate basis reduction required by section 362(e)(2) must be allocated among multiple built-in loss properties in proportion to their respective built-in losses immediately before the transaction.
- BUT: Unlike in section 362(e)(1) transactions, the transferor shareholder (whether foreign or domestic) may *elect* to reduce basis in stock of Acquiring in lieu of Acquiring reducing basis in assets. Section 362(e)(2)(C).

Final Regulations Under Section 362(e)(2)

- T.D. 9633, 78 F.R. 54156 was published on September 3, 2013 containing Treas. Reg. section 1.362-4, a final regulation under section 362(e)(2) (the “Final Regulations”).
- The Final Regulations apply to transactions occurring after September 3, 2013 except for transactions executed pursuant to a binding agreement that was in effect prior to September 3, 2013. Taxpayers can choose to apply the regulation to any transaction that occurred after October 22, 2004. (Note: the proposed regulations under section 362(e)(2) were issued on October 23, 2006; October 22, 2004 was the effective date of section 362(e)(2).)
- The Final Regulations generally adopt the proposed section 362(e)(2) regulations with some structural changes and additions in response to comments.

General Operative Rule

Treas. Reg. Section 1.362-4

- Treas. Reg. section 1.362-4(b) provides that:

“Notwithstanding section 362(a), if . . . Acquiring receives Loss Duplication Property . . . from a person (Transferor) in a Loss Duplication Transaction . . . Acquiring’s basis in such property is equal to the basis of the property determined without regard to section 362(e)(2) . . . reduced by the property’s allocable portion of Transferor’s net built-in loss.”
- “Loss Duplication Property” is any property (i) that is transferred by Transferor to Acquiring in a Loss Duplication Transaction; and (ii) that Acquiring would take with a basis in excess of value immediately after the transaction. Treas. Reg. section 1.362-4(g)(1).
- A “Loss Duplication Transaction” is a section 362(a) transaction in which Acquiring’s aggregate basis in the property received from Transferor would, but for section 362(e)(2), exceed the aggregate value of such property immediately after the transaction. Treas. Reg. section 1.362-4(g)(2).

General Clarifications

Treas. Reg. Section 1.362-4

- Unlike section 362(e)(1), whether section 362(e)(2) applies in a transaction with multiple transferors is determined on a transferor-by-transferor basis. Treas. Reg. section 1.362-4(b).
- Pursuant to Treas. Reg. section 1.362-4(c), section 362(e)(2) generally does not apply to a transaction if:
 1. Transferor distributes the Acquiring stock received in the transaction and, upon completion of the transaction, no person holds Acquiring stock or any other asset with basis determined by reference to transferor's basis in the distributed Acquiring stock (e.g., an asset reorganization); or
 2. Transferor and Acquiring are not part of the U.S. tax system at the time of the transaction and for at least two years thereafter, and the transaction was not effected to reduce or avoid the U.S. federal income tax liability of any person.
- Final regulations fix the allocation of partnership liability issue initially discussed on Slide 18. *See* Treas. Reg. section 1.362-4(g)(12)(ii); *see also* Prop. Treas. Reg. section 1.362-4(c)(4)(ii).

Treas. Reg. Section 1.362-4(h), Example 1*

**Prior to Transaction
(in hands of A)**

Asset 1	
A/B	\$90
FMV	\$60
BIL	\$(30)

Asset 2	
A/B	\$110
FMV	\$120
BIG	\$10

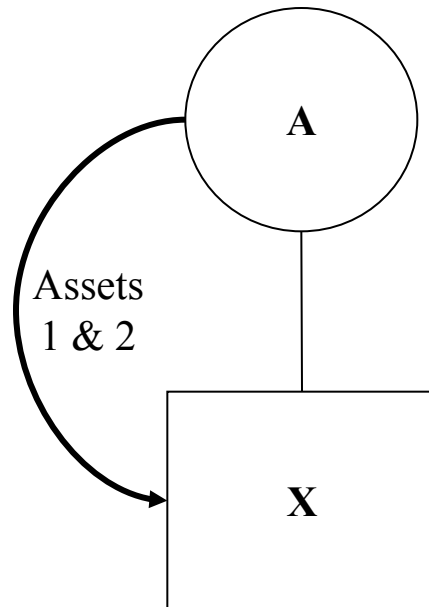

**After Transaction
(in hands of X)**

Asset 1	
A/B	\$70
FMV	\$60
BIL	\$(10)

Asset 2	
A/B	\$110
FMV	\$120
BIG	\$10

*All examples in this part are not subject to section 362(e)(1).

Basis Reduction Allocated among Properties Transferred in Proportion to Respective BILs Example

Prior to Transaction (in hands of A)

Asset 1	
A/B	\$0
FMV	\$100
BIG	\$100

Asset 2	
A/B	\$300
FMV	\$100
BIL	\$(200)

Asset 3	
A/B	\$500
FMV	\$200
BIL	\$(300)

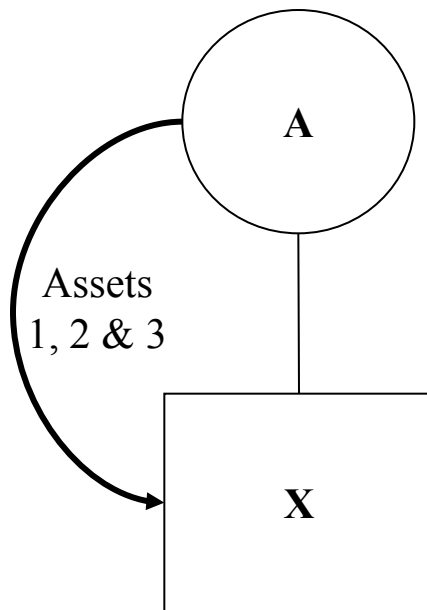

After Transaction (in hands of X)

Asset 1	
A/B	\$0
FMV	\$100
BIG	\$100

Asset 2	
A/B	\$140
FMV	\$100
BIL	\$(40)

Asset 3	
A/B	\$260
FMV	\$200
BIL	\$(60)

Treas. Reg. Section 1.362-4(h)

Example 6: Transfer with Boot

Prior to Transaction (in hands of A)

Asset 1	
A/B	\$80
FMV	\$100
BIG	\$20

Asset 2	
A/B	\$30
FMV	\$25
BIL	\$(5)

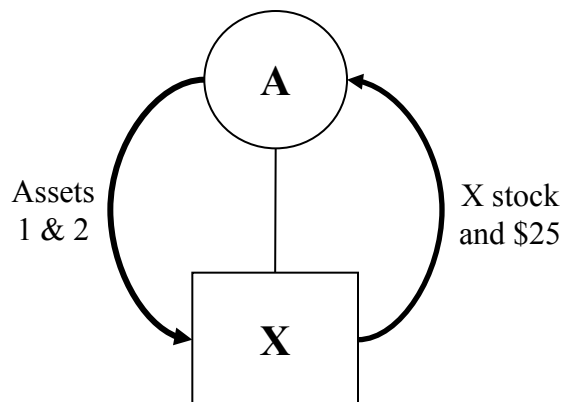

After Transaction (in hands of X)

Asset 1	
A/B	\$100
FMV	\$100
BIG	\$0

Asset 2	
A/B	\$25
FMV	\$25
BIL	\$0

- Consistent with Rev. Rul. 68-55, 1968-1 C.B. 140, 80% of the \$25 (i.e., \$20) is allocated to Asset 1 and 20% of the \$25 (i.e., \$5) is allocated to Asset 2. Thus, A recognizes \$20 of gain in the exchange. Section 351(b). A does not recognize any loss.
- Pursuant to section 362(a), X's basis in Asset 1 would be \$100 (A's \$80 basis in Asset 1 increased by the \$20 of gain recognized by A) and X's basis in Asset 2 would be \$30. As X's aggregate basis (i.e., \$130) exceeds the aggregate value of Asset 1 and Asset 2 (i.e., \$125), the transaction is a Loss Duplication Transaction.
- As a result, section 362(e)(2) applies and X must reduce its basis in Asset 2 by \$5 from \$30 to \$25.
- If a section 362(e)(2)(C) election is made, A's basis in its X stock would be reduced by \$5 from \$105 (i.e., the sum of A's \$80 basis in Asset 1 plus A's \$30 basis in Asset 2, and A's \$20 gain recognized, less the \$25 of cash received by A) to \$100. X's bases in Asset 1 and Asset 2 would be \$100 and \$30 respectively.

The Section 362(e)(2)(C) Election

- Instead of making the basis reductions required by section 362(e)(2), transferor and Acquiring can elect to reduce transferor's basis in the Acquiring stock received in the transaction (the "Election"). Treas. Reg. sections 1.362-4(d)(1) and (2).
 - Section 362(e)(2) does not require basis to be reduced by the amount of contingent liabilities assumed in the transaction that are not required to reduce stock basis pursuant to section 358(h)(2)(A).
 - Basis reduction is allocated among all stock received in proportion to FMV. The tracing requirements of Treas. Reg. section 1.358-2 do not apply.
- The Election can be made protectively.
- The Election is irrevocable once made.

Election Mechanics

- To make the Election:
 1. Transferor and Acquiring must enter into a written, binding agreement to make the Election; and
 2. The “Section 362(e)(2)(C) Statement” must be filed in accordance with Treas. Reg. section 1.362-4(d)(3).
- The Section 362(e)(2)(C) statement must include:
 - The TINs and names of transferor and Acquiring;
 - A statement that transferor and Acquiring have entered into a written, binding agreement to make the Election; and
 - The date(s) of the transaction.

Filing the Section 362(e)(2)(C) Statement

- In descending order of preference, the Section 362(e)(2)(C) Statement must be included on the U.S. return of:
 - i. Transferor, if it is required to file a U.S. return in the year of the transfer;
 - ii. All U.S. shareholders or U.S. partners of transferor, if transferor is a CFC or CFP;
 - iii. Acquiring, if it is required to file a U.S. return in the year of the transfer;
 - iv. All U.S. shareholders or U.S. partners of Acquiring, if Acquiring is a CFC or CFP;
 - v. Transferor, if it later becomes required to file a U.S. return (or the transferor's U.S. shareholders or partners, if it later becomes a CFC or CFP);
 - vi. Acquiring, if it later becomes required to file a U.S. return (or Acquiring's U.S. shareholders or partners, if it later becomes a CFC or CFP); or
 - vii. Any person required to file a U.S. return, or all controlling U.S. owners of a CFC or CFP, that acquires (i) Loss Duplication Property or Acquiring stock received in a Loss Duplication Transaction, or (ii) any property whose basis is determined by reference to such property or stock.

Sections 351(a) and 368(a)(1)(B) Overlap

- Unlike section 362(e)(1), section 362(e)(2) only applies to transactions described in section 362(a).
- However, section 362(e)(2) will apply to a transaction described in both sections 362(a) and (b). *Cf.* Section 304 and section 351/reorganization overlap.

Sections 351(a) and 368(a)(1)(B) Overlap

Treas. Reg. Section 1.362-4(h), Example 2

Prior to Transaction (in hands of P)

P's S2 Shares 1-5	
A/B	\$50
FMV	\$35
BIL	\$(15)

P's S2 Shares 6-10	
A/B	\$25
FMV	\$35
BIG	\$10

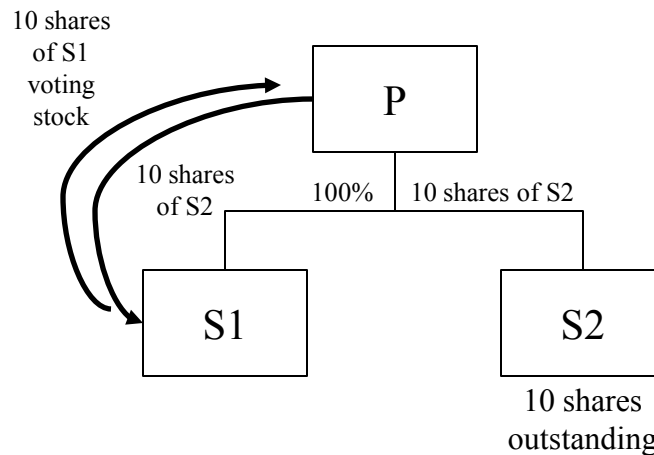

After Transaction (in hands of S1)

P's S2 Shares 1-5	
A/B	\$45
FMV	\$35
BIL	\$(10)

P's S2 Shares 6-10	
A/B	\$25
FMV	\$35
BIG	\$10

- Assume the transfer is described in both sections 351(a) and 368(a)(1)(B).
- The basis of each of S2 shares 1-5 is reduced by \$1 in S1's hands.
- If P and S1 make an Election, P instead reduces its basis in the S1 shares acquired by \$5 in the aggregate (i.e., the net built-in loss in the S2 shares that would have been reduced from S1's basis in S2 shares 1-5).
 - P's basis in the new S1 shares is not determined under the general rule of Treas. Reg. section 1.358-2(a)(2)(i). Treas. Reg. section 1.358-2(a)(2)(viii)(B).
 - Instead, P's basis in each new S1 share is \$7 (i.e., the \$75 aggregate basis of the S2 shares transferred to S1, minus \$5, with the result divided evenly among 10 shares).

Sections 351(a) and 368(a)(1)(B) Overlap Example with Two Classes of Stock

Prior to Transaction (in hands of P)

P's "High Basis" S2 Shares 1-5	
A/B	\$50
FMV	\$35
BIL	\$(15)

P's "Low Basis" S2 Shares 6-10	
A/B	\$25
FMV	\$35
BIG	\$10

"High Basis" S2 shares for 1 share of S1 Class A common stock; "Low Basis" S2 shares for 1 share of S1 Class B common stock

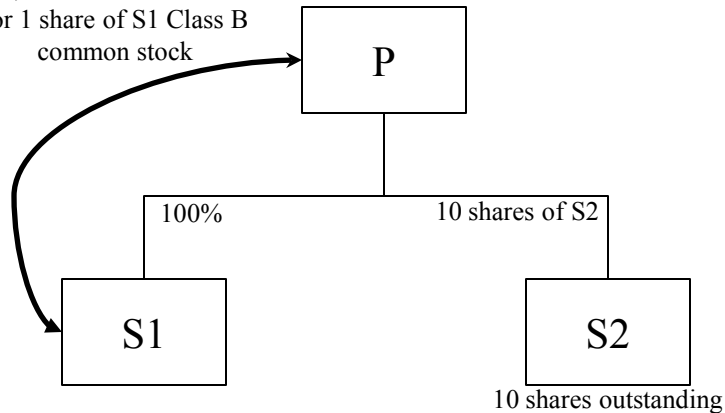

After Transaction (in hands of P)

S1 Class A Common Stock	
A/B	\$35
FMV	\$35
BIL	\$0

S1 Class B Common Stock	
A/B	\$35
FMV	\$35
BIL	\$0

- Assume the transfer is described in both sections 351(a) and 368(a)(1)(B).
- The S1 Class A common stock and S1 Class B common stock have the same FMV but different legal rights.
- If P and S1 make an Election, P's basis in the new S1 Class A and S1 Class B shares is not determined under the general rule of Treas. Reg. section 1.358-2(a)(2)(ii). Treas. Reg. section 1.358-2(a)(2)(viii)(B). Instead, Treas. Reg. section 1.362-4(d)(2)(i) mandates that the basis reduction be allocated among all shares equally in proportion to FMV.
- A policy tension arises between the Congressional policy that making an Election should require transferor to eliminate all built-in loss in the Acquiring stock received in the section 362(e)(2) transaction, on the one hand, and the IRS's position that a transferor transferring multiple properties in a reorganization should not be permitted to obtain blended basis in Acquiring stock, on the other hand. Treasury and IRS concluded that the former policy concerns outweighed the latter. See T.D. 9633, 78 F.R. 54156, 54157 (providing that the pro rata allocation rule "was intended to prevent a preservation of loss that would be contrary to the objective of section 362(e)(2)").

Non-Qualified Preferred Stock Example

Prior to Transaction (in hands of A)

Asset 1	
A/B	\$110
FMV	\$100
BIL	\$(10)

A and X make an Election

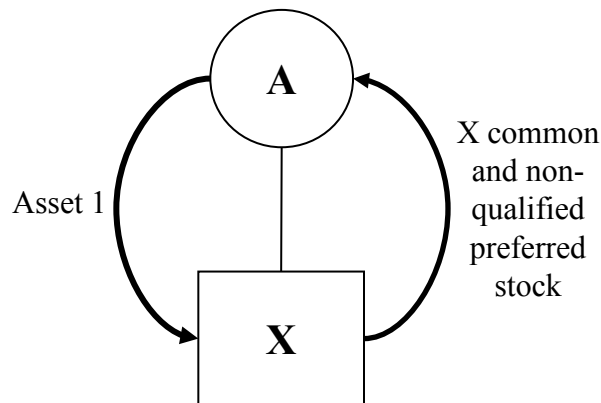

After Transaction

Asset 1		X Common	
A/B	\$110	A/B	\$55?
FMV	\$100	FMV	\$50
BIL	\$(10)	BIL	?

X NQPS	
A/B	\$45?
FMV	\$50
BIL	?

- Is the reduction in A's basis in its X stock allocated to both the common and non-qualified preferred stock ("NQPS")?
- Treas. Reg. section 1.362-4(g)(11) provides that "the term stock means both Acquiring stock and Acquiring securities received by Transferor in the transaction if gain or loss on the receipt of the stock or securities *is* not recognized in whole or in part."
- Treas. Reg. section 1.362-4(d)(1) provides that an Election may be made "... to reduce Transferor's basis in Acquiring stock that is received in the transaction without the recognition of gain or loss. ..."
- Treas. Reg. section 1.362-4(d)(2)(i) provides that, if an Election is made, "[a]n amount equal to the portion of Transferor's net built-in loss . . . that would otherwise be applied to reduce asset basis . . . is allocated among the Acquiring shares received or deemed received in the exchange (in proportion to the value of such shares) and applied to reduce Transferor's basis (determined without regard to section 362(e)(2) and this section) in each such share."
- The definition of the term "stock" arguably could be read to include the NQPS because no gain or loss was recognized by A upon the receipt of the NQPS in this Example (*see* section 351(b)(2)). Under such an interpretation, A's basis in the common stock and the NQPS would be reduced proportionately based upon their relative FMVs under Treas. Reg. section 1.362-4(d)(2)(i) (i.e., a \$5 basis reduction to the common stock and a \$5 basis reduction to the NQPS). Such a result appears inconsistent with the purpose of the statute. We suspect that the drafters intended to treat the receipt of NQPS as the receipt of stock in which gain or loss would generally be recognized.

Flow-Through Entity Election Mechanics

- If a partnership makes an Election, Treas. Reg. section 1.362-4(e)(1) treats the reduction as an expenditure described in section 705(a)(2)(B).
 - Each partner's basis in its interest in the partnership is reduced by its distributive share of the partnership's reduction in stock basis.
 - However, no additional consequences apply for situations in which a partner's basis in the partnership is less than that partner's distributive share of the partnership's stock basis reduction.
- If an S corporation makes an Election, Treas. Reg. section 1.362-4(e)(2) treats the reduction as an expense of the S corporation described in section 1367(a)(2)(D).

Partnership Liability Allocation Issue

Sections 362(e)(1) and (2)

- Absent rectification by the regulations, sections 362(e)(1) and (2) could generate a non-economic gain when an interest in a partnership is transferred to a corporation.
- A and F contribute \$10 each to P/S, which borrows \$40 to purchase an asset worth \$60.
- F transfers its 50% interest in P/S to X in a section 351 exchange.
- Under section 358(a), F's basis in the X stock is \$10 (\$30 basis in the property contributed less \$20 of liability assumption).
- As the FMV of F's 50% interest in P/S is \$10, section 362(e)(1) reduces X's basis in its 50% P/S interest to \$10.
- If X then sells its interest in P/S for \$10 (its FMV), X will recognize \$20 of non-economic gain (\$10 cash received plus \$20 of liability relief less X's \$10 basis in the 50% P/S interest).

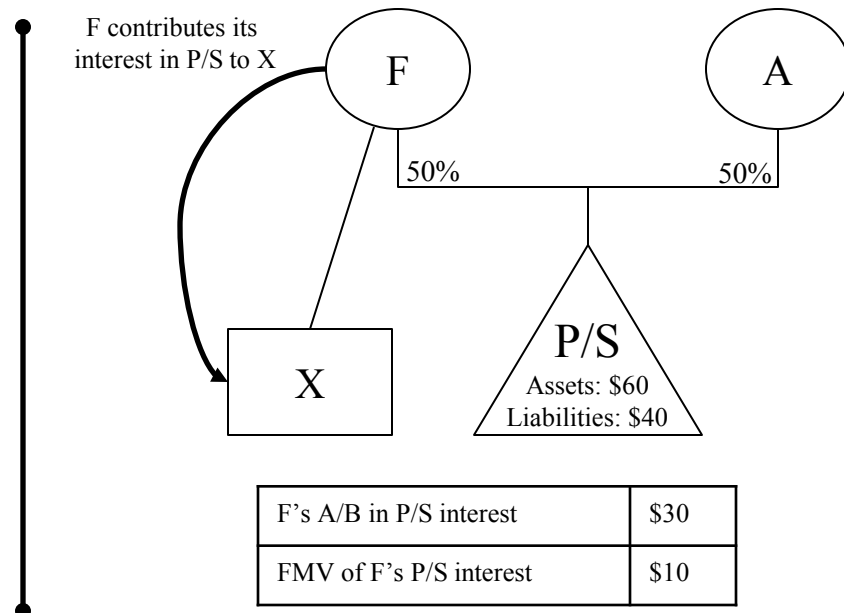

Partnership Allocation of Liabilities

Treas. Reg. Section 1.362-4(g)(12)(ii)

- Treas. Reg. section 1.362-4(g)(12)(ii) provides that the “value” of a partnership interest is:

“[T]he sum of the cash that Acquiring would receive for the interest . . . increased by any [Treas. Reg. section] 1.752-1 liabilities (as defined in [Treas. Reg. section] 1.752-1(a)(4)) of the partnership allocated to Acquiring with regard to such transferred interest under section 752 immediately after the transfer to Acquiring.”.

- The same rule is contained in Prop. Treas. Reg. section 1.362-3(c)(4)(ii) with respect to section 362(e)(1).

Treas. Reg. Section 1.362-4(h)

Example 8, Scenario (ii)(A): Partnership Liabilities

Prior to Transaction

A's A/B in PRS interest	\$247
A's share of PRS's liabilities	\$145

PRS Interest in X's Hands

Cash X would receive on sale of PRS interest	\$100
X's share of PRS's liabilities	\$150

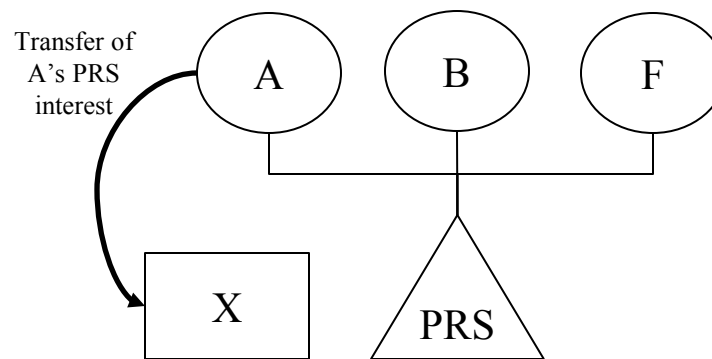

- Assume that PRS does not have a section 754 election in effect and PRS does not have a “substantial built-in loss.” Section 743(d)(1).
- A's PRS interest is not Importation Property.
- But for section 362(e)(2), X's basis in the PRS interest would be \$252 ($\$247 - \$145 + \150). The FMV of the PRS interest would be \$250. Therefore, the transfer is a Loss Duplication Transaction.
- X must reduce its basis in the PRS interest to \$250, and A will take X stock with a basis of \$102 ($\$247 - \145). Section 358.

Treas. Reg. Section 1.362-4(h)

Example 8, Scenario (ii)(C): Partnership Liabilities

Prior to Transaction

A's A/B in PRS interest	\$247
A's share of PRS's liabilities	\$155

PRS Interest in X's Hands

Cash X would receive on sale of PRS interest	\$100
X's share of PRS's liabilities	\$150

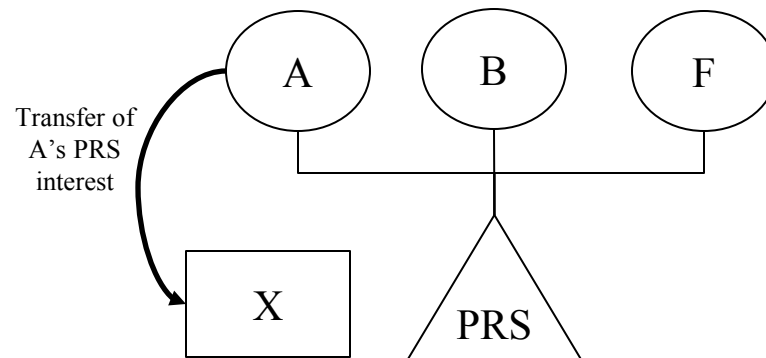

- The exchange is not a Loss Importation Transaction or Loss Duplication Transaction because:
 - Taking into account section 752, X's basis in the PRS interest after the exchange would be A's \$247 basis reduced by A's \$155 share of PRS's liabilities, plus X's \$150 share of PRS's liabilities (\$247 - \$155 + \$150) or \$242.
 - Under Treas. Reg. section 1.362-4(g)(12)(ii), the value of X's interest in PRS is \$250 (upon a sale of its PRS interest, X would receive \$100 of cash and discharge \$150 of PRS liabilities).

Partnership Liabilities and Section 362(e)(2)(C) Election Example

Prior to Transaction

A's outside A/B in PRS interest	\$300
A's share of PRS's liabilities	\$120
A's inside A/B in PRS assets	\$300
FMV of A's PRS interest	\$100

PRS Interest in X's Hands (Prior to Section 362(e)(2) Adjustment)

Cash X would receive on sale of PRS interest	\$100
X's share of PRS's liabilities	\$150
X's inside A/B in PRS assets	\$330

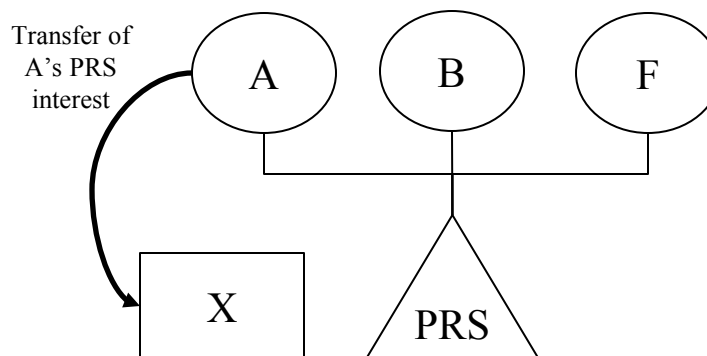

After Transaction (in X's Hands)

X's outside A/B in PRS interest	\$250
X's inside A/B in PRS assets	\$250

- Assume that PRS has a section 754 election in effect.
- But for section 362(e)(2), X's basis in the PRS interest would be \$330 ($\$300 - \$120 + \150).
- The "value" of the PRS interest in X's hands would be \$250 (i.e., $\$100 + \150). Treas. Reg. section 1.362-4(g)(12)(ii).
- X's inside basis in its allocable share of the PRS assets is reduced to \$250 under section 743(b) to match the reduction to X's outside basis in PRS caused by section 362(e)(2).
- Consider application of section 743(b) when A and X make an Election.
 - For example, if A is an original partner of PRS, such election may result in a continuation of inside/outside basis parity with respect to X.
 - Consider implications if A had contributed a built-in loss asset to PRS under section 704(c)(1)(C).

Sections 362(e)(1) and (2) Overlaps

Sections 362(e)(1) and (2) Overlaps

- After applying section 362(e)(1), the preamble to the Proposed Regulations provides that:

“If the transaction is described in section 362(a), the transferred property . . . is then aggregated on a transferor-by-transferor basis to determine whether further adjustment will be required to the bases of loss property under section 362(e)(2).”

78 F.R. 54971, 54975.

- Sections 362(e)(1) and (2) can apply to the same item of property if it still has a built-in loss following the application of section 362(e)(1). *See Prop. Treas. Reg. section 1.362-3(f), Ex. 5.*

Prop. Treas. Reg. Section 1.362-3(f)

Example 1, Scenario (iii)

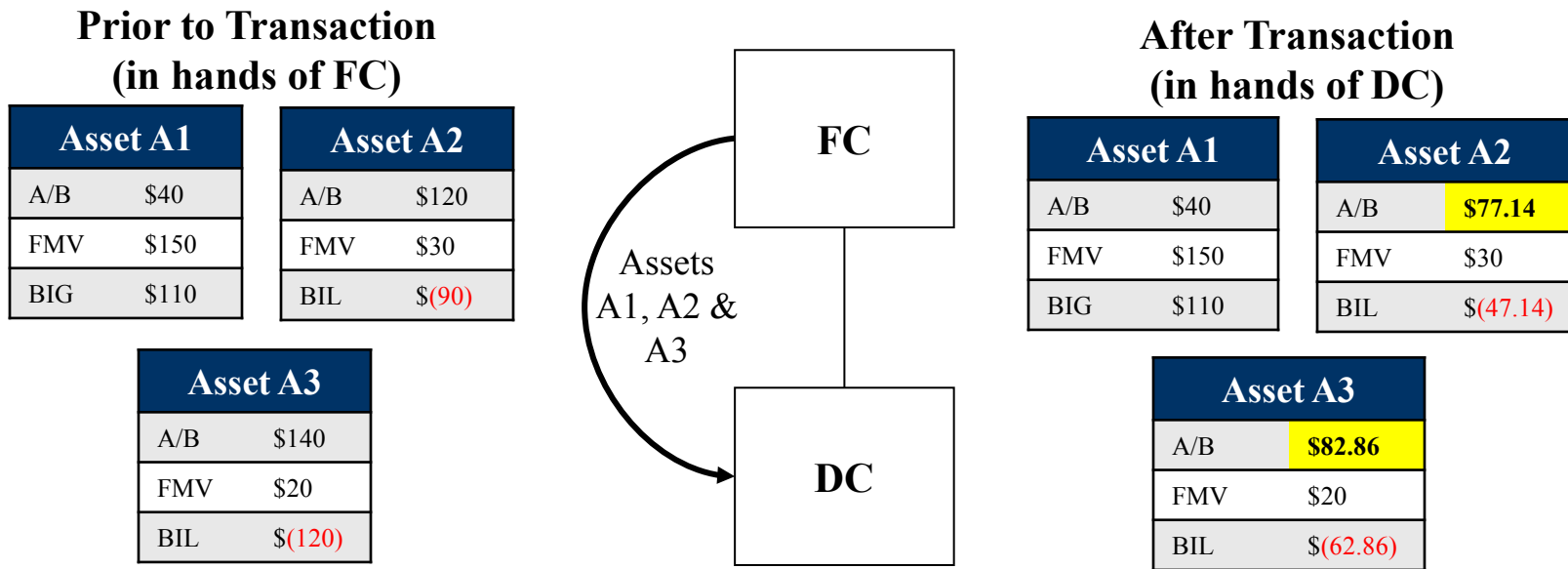

- FC uses A1, A2, and A3 in the conduct of a U.S. trade or business.
- None of the properties is Importation Property.
- Although section 362(e)(1) does not apply to this transaction, section 362(e)(2) still applies to require proportional reduction in the bases of A2 and A3 in DC's hands.

Prop. Treas. Reg. Section 1.362-3(f)

Example 4: Application of Sections 362(e)(1) and (e)(2)

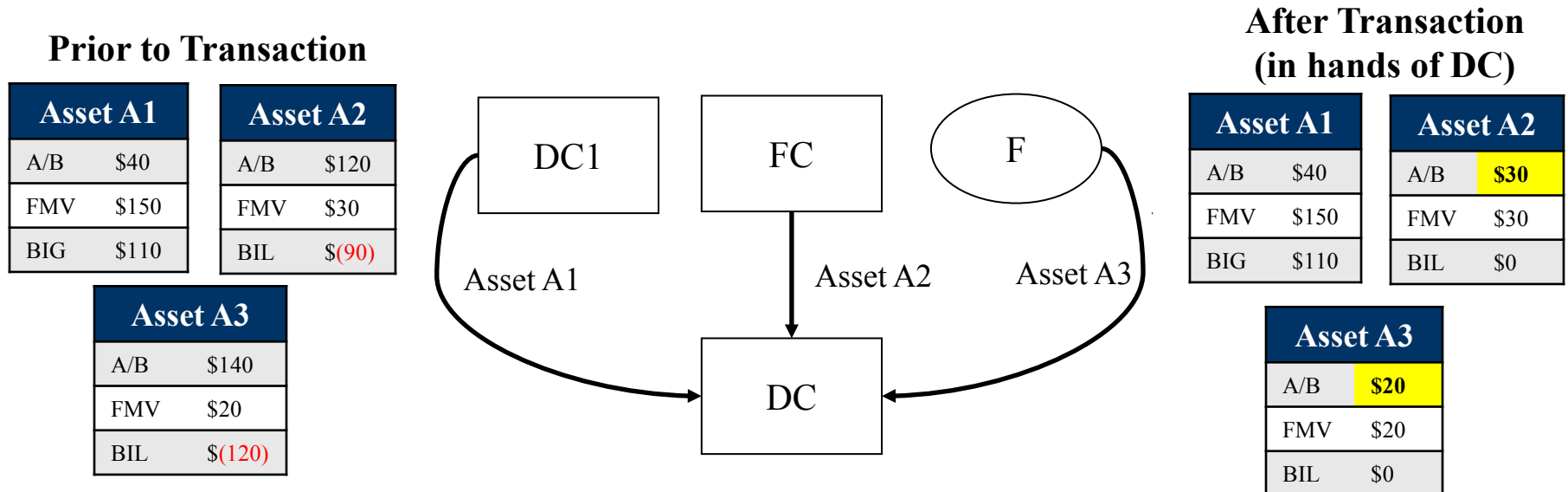

- Assume that A2 is a U.S. real property interest under section 897(c)(1). Neither A1 nor A2 is Importation Property, but A3 is Importation Property.
- Following the application of section 362(e)(1), section 362(e)(2) would apply to FC's transfer of A2 because the transfer would be a Loss Duplication Transaction involving Loss Duplication Property. (The transfer of A1 would not be a Loss Duplication Transaction because A1 is a built-in gain asset and Loss Duplication Transactions, unlike Loss Importation Transactions, are determined on a transferor-by-transferor basis.)

Prop. Treas. Reg. Section 1.362-3(f), Example 5, Scenario (ii) Section 362(e)(2)(C) Election and Section 362(e)(1) Overlap

Prior to Transaction (in hands of FP)

Asset A1	
A/B	\$100
FMV	\$70
BIL	\$(30)

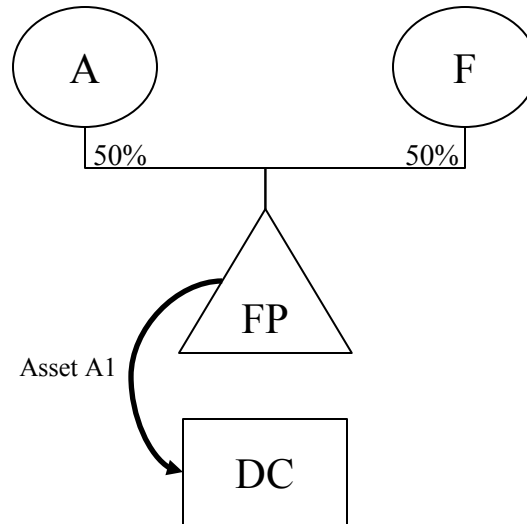

After Application of 362(e)(1) (in hands of DC)

Asset A1	
A/B	\$85
FMV	\$70
BIL	\$(15)

After Application of 362(e)(2) (in hands of DC)

Asset A1	
A/B	\$85
FMV	\$70
BIL	\$(15)

- Asset 1 is tentatively divided and the portion deemed owned by F (having an adjusted basis of \$50 and FMV of \$35) is Importation Property.
- After applying section 362(e)(1), FP and DC make an Election.
- Section 362(e)(1) Consequences: DC reduces its basis in A1 from \$100 to \$85 and FP takes a \$100 basis in its DC stock. A's basis in FP is unchanged.
- Section 362(e)(2) Consequences: DC's basis in A1 remains \$85. FP reduces its basis in its DC stock from \$100 to \$85 pursuant to the Election. The \$15 reduction to FP's basis in DC stock reduces A's basis in his FP interest under section 705(a)(2)(B). Treas. Reg. section 1.362-4(e)(1). FP is not required to reduce its basis in its DC stock to the extent DC's basis in Asset 1 was already reduced under section 362(e)(1).

Circular 230 Disclosure

To ensure compliance with requirements imposed by the IRS, we inform you that any U.S. federal tax advice contained in this communication is not intended or written to be used, and cannot be used, for the purpose of (i) avoiding penalties under the Internal Revenue Code or (ii) promoting, marketing or recommending to another party any transaction or matter addressed herein. Furthermore, the use of the terms, “is,” “will,” “should” and similar terms are not meant to convey an opinion on the tax consequences of the transactions.